



# Multipure

## Drinking Water Systems

---

Installation, Operation and Maintenance Manual

## Multipure CB Plus RO



### **Warning**

Please read manual carefully before proceeding with installation. Your failure to follow any attached instructions or operating parameters may lead to the product's failure and possible damage to property.

**Save Manual for future reference.**



System Tested and certified by NSF International against NSF/ANSI Standards 42, 53, and 58 for the reduction of claims specified on performance data sheet.

Multipure Drinking Water Systems · 7251 Cathedral Rock Drive · Las Vegas, NV 89128  
866-622-9373 · [www.multipureplus.com](http://www.multipureplus.com) · [info@multipureplus.com](mailto:info@multipureplus.com)

Thank you for your purchase of a Multipure Reverse Osmosis system. With proper installation and maintenance, this system will provide you with high quality water for years to come. All of Multipure's water treatment products are rigorously tested by independent laboratories for safety and performance. If you have any questions or concerns, please contact our customer service department at 1-866-622-9373 or email [info@multipureplus.com](mailto:info@multipureplus.com).

## Table of Contents

Operational Parameters	3
Contents of Reverse Osmosis System	3
Tools Recommended for Installation	3
Drill a Hole for the Faucet in a Porcelain Sink	4
Punch a Hole for the Faucet in a Stainless Steel Sink	4
Faucet Installation	5
Adapta Valve Installation	6
Reverse Osmosis Module Mounting	6
Drain Saddle Installation	7
Tank Valve Installation	7
Clear Tube Installation	7
Blue Tube Installation	8
Black Tube Installation	8
Red Tube Installation	8
MP750SI Final Filter Installation	9-11
Green Tube Installation	11
Start up Instructions	12
6 Month System Maintenance	13-14
Annual Maintenance	15-16
Membrane Maintenance	17
Check Air Pressure in the Tank	18
Trouble Shooting	19
Warranty	20
Diagram and Parts List for 5 Stage Reverse Osmosis	21
Performance Data Sheet / California Certification	22-26
Service Record	27

## Operational Parameters

Operating Temperatures:	Maximum 100°F (37.8°C)	Minimum 40°F (4.4°C)
Operating Pressure:	Maximum 100 psi (7.43 g/cm <sup>2</sup> )	Minimum 40 psi (2.8 kg/cm <sup>2</sup> )
pH Parameters:	Maximum 11	Minimum 3
Iron:	Maximum 0.2 ppm	
TDS (Total Dissolved Solids)	< 1800 ppm	
Turbidity:	<5NTU	
Hardness:	Recommended hardness not to exceed 10 grains per gallon, or 171 mg/L of hardness as CaCO <sub>3</sub> . System will operate with hardness over 10 grains but the membrane life may be shortened. Addition of a water softener may lengthen the membrane life.	
Note:	The operating pressure in your home should be tested over a 24 hour period to attain the maximum pressure. If it is above 100 psi then a pressure regulator will be required.	
Note:	Reverse Osmosis water should not be run through copper tubing as the purity of the water will leach copper and cause an objectionable taste in water and cause pin holes to form in tubing. Be sure to follow any state or local regulations	

***Do not use with water that is microbiologically unsafe or of unknown quality, without adequate disinfection before or after the system. Systems certified for cyst reduction may be used on disinfected waters that may contain filterable cysts.***

## Contents of Reverse Osmosis System

5 Stage RO System has:

1 Tank - White	1 sediment filter
1 RO Membrane - White	2 pre-filters, 5 micron
1 Parts Bag	1 MP750 post filter
1 Faucet Bag	1 bracket
1 Manual	1 hand tool
1 Nitrate/Nitrite test strip	

If any of the items are missing, please contact Multipure prior to installing.



## Tools Recommended for Installation

- 1 1/4" Hole saw bit for faucet opening
- Round knock-out punch for Stainless Steel sinks, 1/2" and 1 1/4"
- Adjustable Wrench
- Sharp Knife
- 1/2" - 5/8" Open end wrenches
- Phillips screw driver
- Needle nose pliers - Adjustable Pliers
- Electric Drill
- 1/8", 1/4", 7/16" and 1" Drill bits



**SEE PAGE 21 FOR AN INSTALLATION OVERVIEW AND PARTS LIST.**

## Drill a Hole for the Faucet in a Porcelain Sink

A dripping or gurgling sound may be heard coming from the Air Gap hole in the faucet and drain when the system is running. This is normal and in compliance with UPC Plumbing Codes.

**Note: Porcelain sink surface material is extremely hard and can crack or chip quite easily. Use extreme caution when drilling. Multipure Drinking Water Systems accepts no responsibility for consequential damage resulting from the installation of faucet.**

Most sinks are predrilled with 1 1/2" or 1 1/4" diameter holes (if you are already using it for a sprayer or soap dispenser, see step 1).

Step 1 Determine desired location for the faucet on your sink and place a piece of masking tape on location where hole is to be drilled. Mark the center of the hole on the tape.



Step 2 Using a variable speed drill on the lowest speed, drill a 1/8" Pilot hole through both porcelain and metal casing of sink at the center of the desired location. (If drill bit gets hot, it may cause the porcelain to crack or chip).

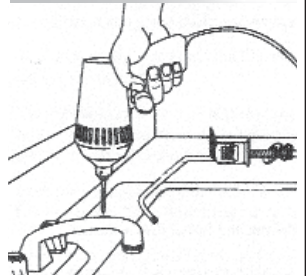

Step 3 Using a 1.00" or 1.25" hole saw, proceed to drill the large hole. Keep drill speed on the slowest speed and use lubricating oil or liquid soap to keep the hole saw cool during cutting.



Step 4 Make sure the surroundings of the sink are cooled before mounting the faucet to the sink after drilling. Remove all sharp edges with a file.



## Punch a Hole for Faucet in a Stainless Steel Sink

**NOTE:** If mounting faucet to a Stainless Steel Sink, you will need a 1/2" and 1 1/4" Hole punch. The faucet opening should be centered between the back splash and the edge of the sink, ideally on the same side as the vertical drain pipe.

Step 5 Drill a 1/4" pilot hole. Use a 1/2" Hole punch and an adjustable wrench to punch the hole in the sink.

The faucet can now be installed.



## Installing the Reverse Osmosis Faucet

**NOTE:** The Reverse Osmosis Models come with an air gap faucet. To install, you will need a 1/8", 7/16" and 1" drill bits. Minimum mounting hole size: 1.00"; Maximum mounting hole size: 1.25". Maximum torque on toggle bolt: 5lb.in. Proceed as follows:

**Step 6** Follow the instructions for drilling a hole in your sink (Steps 1 through 5)

**Step 7** Gather and identify the faucet components.

**Step 8** Remove the faucet base (with tubing attached) and faucet spout from their respective plastic bags. From above the sink, feed the faucet tubing and toggle bolt down through the 1.00" to 1.25" mounting hole in the sink. Ensure that the soft rubber gasket is uniformly positioned between the base and the top of the sink.

**Step 9** Align the faucet base so that the handle is on the right side and the base is sitting flush on the sink top. Turn the handle down (towards you) to the ON position to reveal the tightening screw (located where the spout will be inserted). Using a phillips head screwdriver, turn the screw clockwise until the toggle bolt secures the faucet base snug onto the sink top. Do not over-torque toggle bolt (5lb.in max).

**Step 10** Once the faucet base is securely fastened to the sink top, insert the faucet spout into the faucet base until it is fully seated. Turn the handle up (away from you) to the OFF position.

### **Step 11 TUBING CONNECTONS:**

**NOTE:** *Do not cut any tubing at this time. Proceed with tubing installations when you get to the pages noted below.*

**Blue Tube** from the faucet should be connected to the MP750SI Final Filter as shown on page 9.

**Red Tube** from the faucet should be connected to the waste water output port on the RO system as shown on page 8.

**Black Tube** from the faucet should be connected to the drain as shown on page 8.

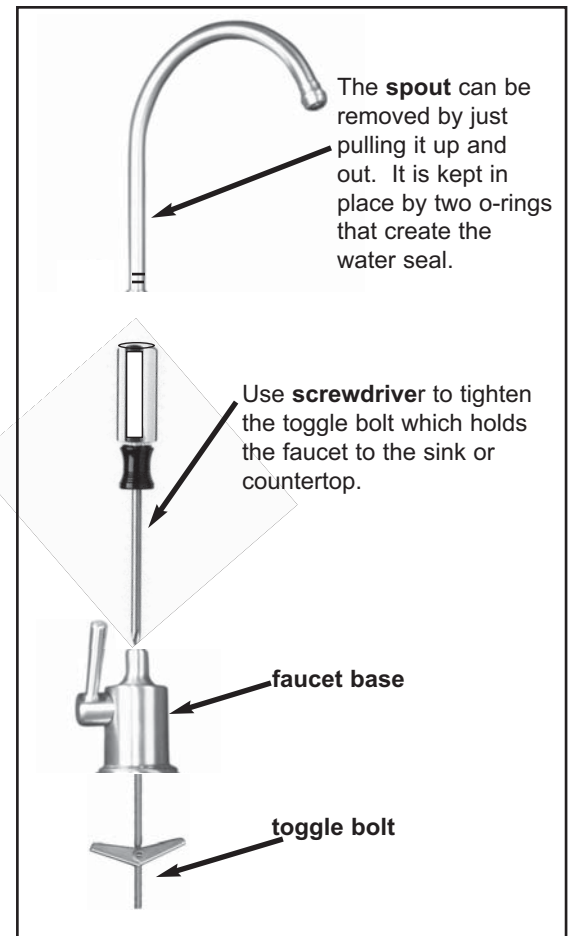
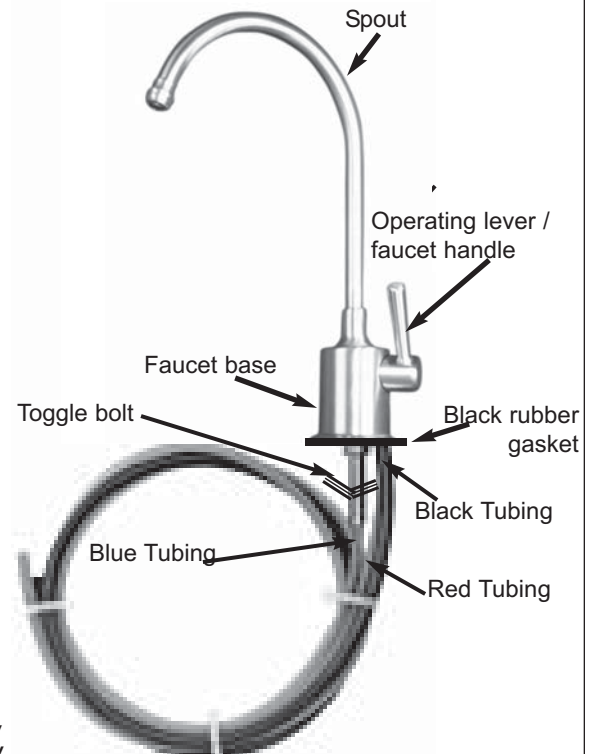

## Adapta Valve Installation -- Item #23 on page 21

Step 12 Turn off the cold water supply to the faucet by turning the angle stop valve completely off.

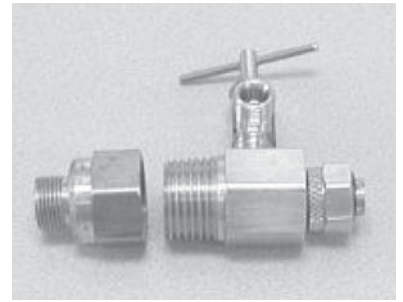

3/8" configuration

Step 13 Attach adapta valve as illustrated in the three photos to the right, choosing the configuration (3/8" or 1/2") that fits your plumbing. (When attaching the adapta valve to straight pipe threads, use Teflon tape on the threads).

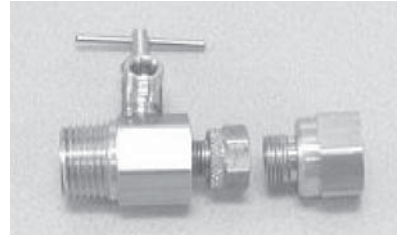

1/2" configuration

**CAUTION:** Water supply line to the system must be from the cold water supply line. Hot water will severely damage your system.



## Reverse Osmosis Module Mounting

Step 14 Determine best location for the RO module to be mounted to allow for future system maintenance. The parts bag has 2 self tapping screws (#27). Using a phillips screwdriver, screw them into the cabinet wall 10 3/4" apart and 16" from the bottom of the cabinet.



**NOTE:** *Do not cut any tubing at this time.*



## Drain Saddle Installation

- Step 15 Gather the pieces of the drain saddle (#30)
- 1 Black compression nut
  - 1 Semi-circle bracket with opening
  - 2 Screws
  - 1 Foam washer/gasket
  - 2 Nuts for screws
  - 1 Semi-circle bracket

- Step 16 The small square black foam gasket with a circle cut out of the middle must be applied to the inside of the drain saddle. Remove sticky tape backing and stick to the drain saddle as shown.

- Step 17 Drill a 1/4" hole through the drain pipe at least 1 1/2" above the nut of the P-trap to allow for the removal of the P-trap, if necessary. Assemble the drain saddle around the drain pipe. Position the drain saddle over the drilled hole in pipe. Insert screw driver into pipe. Using Phillips screw driver, tighten screws evenly and securely on both sides of the drain saddle. Attach black compression nut, but do not tighten at this time. The black tubing will be installed later.



**CAUTION: Do not over tighten the screws. It may crack the drain saddle.**

## Tank Valve Installation - Item #21 on page 21

- Step 18 Teflon tape must be applied on the fitting on the top of the tank in a clockwise direction. Wrap (4 - 7 turns) around the male pipe threads (MPT) on the Stainless Steel fitting on top of the tank.

- Step 19 Connect the shut-off valve (#21) (supplied in the parts bag) to the threaded fitting on the top of tank.

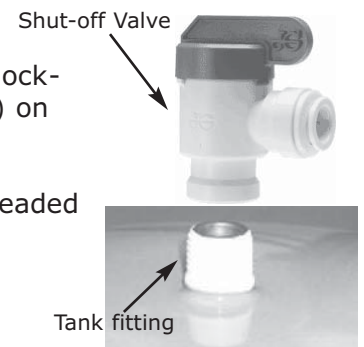

## Tube Connections

**Note: Do not cut tubes until you get to those steps. Remove caps, if any, from tubes before cutting tubes. Use wire cutters or sharp knife to make straight square cut. Do not use scissors.**

## Clear Tube Connection

- Step 20 Cut 4"-6" from the clear 1/4" tubing. Insert the end of this small section of tubing into the shut-off valve previously connected to the tank. Insert the other end of the tubing into the middle port of the 1/4" x 1/4" x 1/4" tee connector (MC445).

- 20a The tubing must be fully inserted in the connector fitting; it is recommended that you measure and mark the end of the tubing that you are inserting in the fitting to assure that it is inserted as far as it will go. The 1/4" tubing should be inserted about 5/8". Push the tubing through the small hole in the connector until you feel resistance. At this point, the tubing is not fully inserted. Then push firmly until the tubing is inserted as far as it will go.



Instructions for installing the remaining clear tubing can be found on page 10, step 32.

## Blue Tube Connection

Step 21 Position the tank in the desired location. Stand it upright or lay it on its side (using the black plastic stand) (#31). Measure the blue tube from the RO module over to the tank and cut to length. Insert the blue tubing into either side of the 1/4" x 1/4" x 1/4" tee connector closest to the RO module.

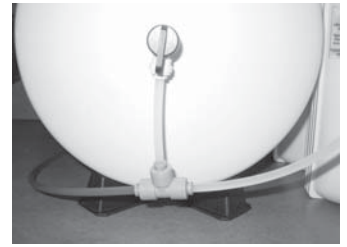

21a The tubing must be fully inserted in the connector fitting; it is recommended that you measure and mark the end of the tubing that you are inserting in the fitting to assure that it is inserted as far as it will go. The 1/4" tubing should be inserted about 5/8". Push the tubing through the small hole in the connector until you feel resistance. At this point, the tubing is not fully inserted. Then push firmly until the tubing is inserted as far as it will go.

## Faucet Tube Connection

For the Blue and Clear Faucet Tube Connection instructions follow the CBT-VOC-SI/CB1100PI Installation instructions.

NOTE: To connect the 1/4" Blue Tube from the faucet, and the 1/4" Clear Tube from the tank, see CBT-VOC-SI/CB1100PI Final Filter Installation. Do not connect the faucet tubing until you get to that step.



## Black Tube Connection from Faucet

NOTE: The tubing must be as **SHORT and STRAIGHT** as possible, making a downward slope from the faucet to drain saddle to allow for proper drainage.

Step 22 Measure the black tube from **faucet** to the black drain saddle and make a straight cut with a sharp knife through tube. **Do not use scissors.**

Step 23 Remove black plastic nut from drain saddle. Slip black tube through black nut. Insert black tube into the opening in the drain saddle and tighten the black nut securely.

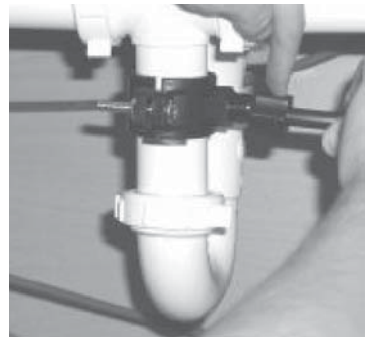

NOTE: This is a gravity fed line, if there is any bend in the tube, the rinse water will not flow into the drain properly. Water will back up and come out the air gap hole in the side of the faucet base.

## Red Tube Connection from Faucet

Step 24 Using the white plastic union (#16) in the parts bag, determine where the **red tubing from the faucet** and the **black tubing from the RO membrane** housing would join together comfortably. Using a knife, cut the tubes leaving a straight cut on both tubes. Insert both red tubes in either end of the white plastic union. Use a 5/8" wrench to tighten both of the white plastic nuts securely.



## CBT-VOC-SI/CB1100PI - Item #1 on page 21

The filter cartridge is shipped outside the unit housing to protect your filter cartridge and housing from damage during shipping. Be sure to insert the filter cartridge into the Final Filter housing before installing it. Complete, detailed instructions are provided with the filter cartridge.

- Step 25 Gather the parts needed to install the CBT-VOC-SI/CB1100PI Final Filter:
- 1 housing
  - 1 CBTVOC/CBN filter
  - 2 1/4" male connector

Step 26a Connect the 1/4" male connector to the OUTLET opening on the unit housing by turning clockwise. Tighten by hand and then give one to two extra turns with a wrench.

27b Connect 1/4" male connector to the INLET opening on the unit housing by turning clockwise. Tighten by hand and then give one to two extra turns with a wrench.

Step 27 Remove plastic wrapper and instruction wrapper from the filter cartridge. With the Final Filter housing in an upright position, open the unit by unscrewing the knob on the Locking V-Band. Spread it apart and remove the Locking V-Band.

Step 28a Separate the unit, leaving the black O-ring in place.

28b Screw the filter cartridge into the housing top by turning the cartridge until firm. DO NOT OVERTIGHTEN.

28c Connect the housing top with bottom and replace Locking V-Band; replace black knob and turn until tight. Be sure that the Locking V-Band is fastened tightly by checking it to be sure that it is secured evenly around the housing top and bottom, and hand-tighten the black knob until it is as tight as possible.

Step 29a Insert the blue tubing **from the faucet** into the 1/4" **outlet** connector -- insert into the hole in the connector as far as it will go. Note: First, confirm that the tubing has a straight square cut.

29b The tubing must be fully inserted in the connector fitting; it is recommended that you measure and mark the end of the tubing that you are inserting in the fitting to assure that it is inserted as far as it will go. The 1/4" tubing should be inserted about 5/8".

29c Push the tubing through the small hole in the connector until you feel resistance. At this point, the tubing is not fully inserted. Then push firmly until the tubing is inserted as far as it will go. See measurements above.

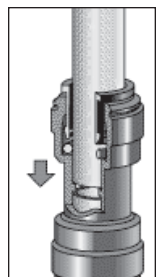
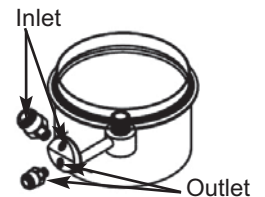
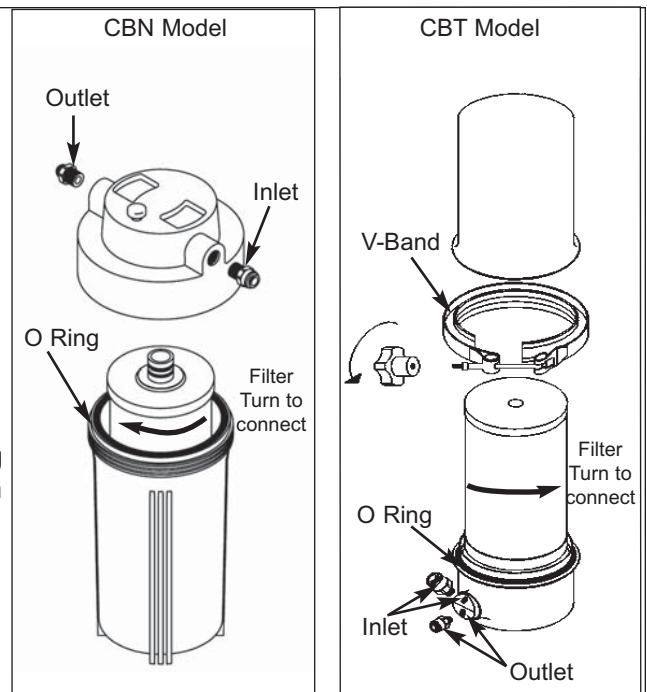

## CBT-VOC-SI/CB1100PI Installation - continued

Step 30 Connect the loose green tubing to the adapta valve (installed at steps 12 and 13).

30a Remove tee (#17), plastic Delrin sleeve (#18), and brass insert (#19) from the parts bag. Place tee on the green tube first, then the Delrin sleeve (taper end must point to the end of the tube) and then insert the brass insert into the end of the tube.

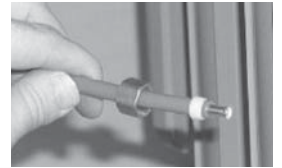

30b Insert one end of the green tube into the 1/4" opening at the needle valve on the adapta valve until it stops. DO NOT CUT THE GREEN TUBE.

30c Slide the nut and Delrin sleeve down and thread onto the male pipe threads. Use a 1/2" wrench to secure tightly.

30d For the purpose of **flushing** the CBT-VOC-SI/CB1100PI Final Filter, insert the other end of the green tube into the 1/4" inlet connector of CBT-VOC-SI/CB1100PI.

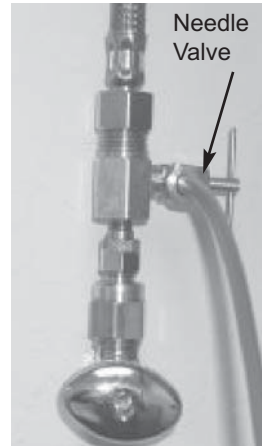

Step 31a To **flush** the Final Filter, turn on cold water supply by turning the handle on the needle valve.

31b Then open the RO faucet by lowering the operating lever (handle) and lock in the down position.

31c Allow water to flow through the CBT-VOC-SI/CB1100PI Final Filter for about 5 minutes so that all air can escape.

31d Close the RO faucet and check for leaks.  
- Check the V-Band to confirm that it is secured evenly around the housing top and bottom.  
- Hand-tighten the black knob on the V-Band until it is as tight as possible

31e Allow water to again run through the unit to waste for approximately 20 minutes to charge the carbon and flush out loose carbon particles.

31f Shut off the water to the faucet and water supply at the needle valve.

31g **Disconnect the green tube** from the inlet port of the CBT-VOC-SI/CB1100PI. Instructions on connecting the green tube to the RO Pre-Filter module are provided on page 11, step 35. Wait until you get to that step to make that connection.

**NOW YOU ARE READY TO CONNECT THE FINAL FILTER TO THE TANK.**

## Clear Tube Connection

Step 32a To connect the CBT-VOC-SI/CB1100PI Final Filter to the Tank, use about 12" TO 18" of the 1/4" clear tubing. Make sure that both ends are cut straight.

32b Insert one end of the clear tube into the 1/4" **inlet** connector as far as it will go. The tubing must be fully inserted in the connector. The 1/4" tubing should be inserted about 5/8". Push the tubing through the small hole in the connector until you feel resistance. At this point, the tubing is not fully inserted. Then push firmly until the tubing is inserted as far as it will go.

NOTE: Retain the remaining clear tubing for flushing the RO pre-filters at page 11, step 36 when you get to that step.

## CBT-VOC-SI/CB1100PI Installation - Connecting to the Tank

- Step 33 Insert the other end of the clear tube to the 1/4" tee connection at the tank. The tubing must be fully inserted into the tee. The 1/4" tubing should be inserted about 5/8". Push the tubing through the small hole in the tee until you feel resistance. At this point, the tubing is not fully inserted. Then push firmly until the tubing is inserted as far as it will go.



## Green Tube Connection

- Step 34 Drape the green tube connected to the adapta-valve (previously installed - see page 6 & 10) over to the "IN" side of the RO Pre-Filter module, leaving a gentle curve in the tubing. DO NOT SHORTEN THE GREEN TUBE. You will need the full length of the green tube for flushing the CBT-VOC-SI/CB1100PI Final Filter for future filter changes.

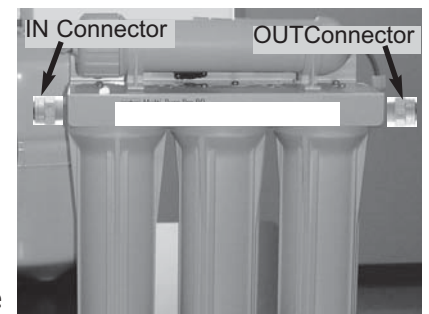

- Step 35 Insert the green tube into the 1/4" connector on the "IN" side of the RO Pre-filter module. The tubing must be fully inserted in the connector. The 1/4" tubing should be inserted about 5/8". Push the tubing through the small hole in the connector until you feel resistance. At this point, the tubing is not fully inserted. Then push firmly until the tubing is inserted as far as it will go.

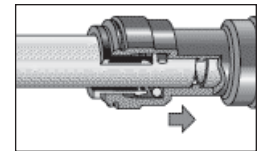

### Flush the RO Module Pre-Filters

- Step 36 Insert remaining **clear** tubing into 1/4" connector on "OUT" side of the RO Pre-Filter module. Drape the other end of the clear tubing up to the sink drain, or to a large bucket.
- Step 37 To flush the RO pre-filters, turn on the cold water supply by turning the handle of the needle valve counter-clockwise.
- Step 38 Allow the water to run through to waste for approximately 5 minutes. Then, Shut off the water at the needle valve by turning the handle clockwise until it stops.
- Step 39 Disconnect the clear tubing from the "OUT" side port on the RO Pre-filter module. To disconnect the tubing, first ensure that the system is depressurized. Then, push in the collet against the face of the fitting. With the collet held in this position, the tubing can be removed. The fitting can then be reused.

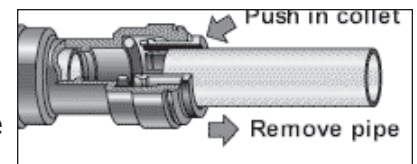

NOTE: Retain the clear tubing for flushing the RO pre-filters in the future.

- Step 40 Attach the **green tubing from the automatic shut-off valve** (Item #22) to the "out" connector of the RO Pre-filter module. The tubing must be fully inserted in the connector. The 1/4" tubing should be inserted about 5/8". Push the tubing through the small hole in the connector until you feel resistance. At this point, the tubing is not fully inserted. Then push firmly until the tubing is inserted as far as it will go.

## Start-Up Instructions

- NOTE:** If your system is hooked up to an Ice Maker, turn Ice Maker off until tank has filled, then flushed and refilled before allowing water to flow to Ice Maker. The system should have a ball valve installed before the Ice Maker so it can be closed to prevent water flowing to the Ice Maker. Your tank must be allowed to fill up in order for the unit to shut off. (If you are installing an Ice Maker kit, tee off after the final filter).
- Step 1 Turn on the incoming cold water. Turn tank valve to "on" position. Check the system for leaks and tighten any fitting as necessary. (Check over the next 24 hours to ensure no leaks are present).
- Step 2 Open the RO faucet and leave open until after water begins to trickle out. This will take several minutes. It will come out slowly. Then close the RO faucet.
- Step 3 The tank will take between 4 to 6 hours to fill completely, depending on the size of the membrane, local water temperature and pressure. There is an average of 5 gallons of reject water for every 1 gallon of filtered water produced.
- Step 4 Then fill the RO tank again. Now you may use your RO system for all of your drinking water needs.
- Step 5 Inspect the reverse osmosis system periodically to ensure the unit is functioning properly.

## 6 Month System Maintenance

For filters or replacement parts, contact Multipure Corporation at 866-622-9372 or at [www.multipureplus.com](http://www.multipureplus.com)

### Items Needed

- 1 Ten inch sediment filter (CBC110)
- 2 Ten inch carbon prefilters (CBC112)
- 1 Bucket to catch water from filter housings
- 1 Hand tool shipped with the system or wrench to loosen filter housings.

**NOTE:** Keep RO Module in an upright position while replacing housing bottom in order to keep O-rings properly seated.

**Step 1** Turn off incoming water supply to the RO at needle valve on adapta valve.

**Step 2** Turn off the valve at the RO tank by turning 1/4 turn.

**Step 3** For more leverage, leave RO module attached to wall of cabinet. If you are unable to access the module, you may remove it to change filters. Starting with the closest housing, remove the housing bottom, using the hand tool to loosen, and empty water, then discard filters. Continue on to the 2nd and 3rd housings.



**Step 4** Clean all filter housings with a mild soap solution and rinse with water. Check O-rings and lubricate with water soluble lubricant. Water based lubricants can be used, but petroleum based lubricants (such as Vaseline) must not be used.



**Step 5** The sediment filter has a cloth-like appearance. It must be in the FIRST housing on the left (where the water inlet connects).



**Step 6** Carbon block prefilters have a mesh covering and a white rubber gasket on each end. Insert the carbon prefilter with gasket facing up. Be sure to seat the black O-ring properly in the housing bottom.



**Step 7** Repeat this step for the third housing.



**Step 8** Discard used filters in your normal refuse.



## 6 Month System Maintenance - continued

**IMPORTANT:** Follow steps 9, 10 and 11 to flush carbon particles from pre-filters so as not to clog the flow restrictor which could then foul the membrane.

- Step 9 After changing pre-filters, disconnect the green tube at the "out" side port of the RO pre-filter module. See page 11, step 39 for instructions on how to disconnect tubing.
- Step 10 Use the clear tubing from the original installation and flush out all carbon particles from the carbon pre-filters. (Refer to page 11, steps 36 - 39 for flushing instructions.) As soon as the water runs clear, turn off the incoming water and re-attach the green tube between the "out" connector of the RO Pre-filter module and the automatic shut-off valve (Item #22).
- Step 11 Turn on the incoming cold water. Check the system for leaks and tighten any fitting as necessary. (Check over the next 24 hours to ensure no leaks are present).
- Step 12 Open the valve on the RO faucet tank.



**NOTE:** Retain the clear tubing for flushing the RO pre-filters in the future.

**Inspect the reverse osmosis system periodically to ensure the unit is functioning properly.**

### **Nitrate/Nitrite Testing**

The RO system is acceptable for treatment of influent concentrations of no more than 27 mg/L nitrate and 3 mg/L nitrite in combination measured as N and is certified for nitrate/nitrite reduction only for water supplies with a pressure of 280 kPa (40 psig) or greater.

It is recommended that user's water be sampled and tested for nitrate/nitrite at least once a year to confirm that the RO system is performing its function.

Included in this shipment is a nitrate/nitrite test strip. Within one year of installation of the RO System you should test your water. Just dip the strip in the treated water, following the instructions included with the test strip.

If the levels of nitrate or nitrite exceed the influent concentrations shown above, the RO membrane should be replaced.

## Annual Maintenance

For filters or replacement parts, contact Multipure Corporation at 866-622-9372 or at [www.multipureplus.com](http://www.multipureplus.com)

- Step 1 Perform 6 month system maintenance (previous section). Ensure the system is depressurized by turning the valve on the tank 1/4 turn until it stops and turn off water supply at adapt valve.
- Step 2 The CBT/VOC/CBN filter (used in the CBT/CBN Final Filter) should be replaced annually. See replacement filter wrap for additional instructions on replacing the CBN/CBT-VOC carbon block filter in the CBT-VOC-SI/CB1100PI Final Filter unit. Remove plastic wrapper and instruction wrapper from the filter cartridge. With the Final Filter housing in an upright position, open the unit by unscrewing the knob on the Locking V-Band. Spread it apart and remove the Locking V-Band.
- Step 3 Separate the unit, leaving the black O-ring in place.
- Step 4 Remove the used filter and discard it in your normal refuse.
- Step 5 Clean and rinse out the stainless steel housing.
- Step 6 Screw the new filter cartridge into the housing top by turning the cartridge until firm. **DO NOT OVERTIGHTEN.**
- Step 7 Connect the housing top with bottom and replace Locking V-Band; replace black knob and turn until tight. Be sure that the Locking V-Band is fastened tightly by checking it to be sure that it is secured evenly around the housing top and bottom, and hand-tighten the black knob until it is as tight as possible.

### Flush the carbon block filter, as follows:

- Step 8 Disconnect the green tube from the "in" connector of the RO Pre-filter module. See page 11, step 39 for instructions on how to disconnect tubing.

**NOTE:** You will reconnect the green tube after the Final Filter is flushed.

- Step 9 Disconnect the clear tubing to the "inlet" connector of the CBT-VOC-SI/CB1100PI housing.
- Step 10 Connect the end of the green tubing that you disconnected from the RO Pre-filter module to the "inlet" port of the CBT-VOC-SI/CB1100PI.

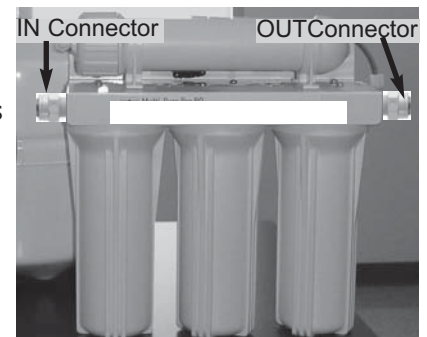

## Annual Maintenance - continued

- Step 11a To flush the Final Filter, turn on cold water supply by turning the handle on the shut-off valve and/or adapta valve / needle valve.
- 11b Then open the RO faucet by turning the operating lever (handle) and lock in the down position.
- 11c Allow water to flow through the CBT-VOC-SI/CB1100PI Final Filter for about 5 minutes so that all air can escape.
- 11d Close the RO faucet and check for leaks.  
- Check the V-Band to confirm that it is secured evenly around the housing top and bottom.  
- Hand-tighten the black knob on the V-Band until it is as tight as possible
- Step 12 Allow water to again run through the unit to waste for approximately 20 minutes to charge the carbon and flush out loose carbon particles.
- Step 13 Shut off the water at the needle valve / adapta valve.
- Step 14 Disconnect the green tube from the CBT-VOC-SI/CB1100PI.

### **NOW RECONNECT THE FINAL FILTER TO THE TANK.**

NOTE: Be sure to fully insert the tubing in the connector. Push the tubing through the small hole in the connector until you feel resistance. At this point, the tubing is not fully inserted. Then push firmly until the tubing is inserted as far as it will go.

- Step 15 Insert the end of the clear tube back into the 1/4" "inlet" fitting on the CBT-VOC-SI/CB1100PI.

### **RECONNECT THE GREEN TUBING TO THE RO Module.**

NOTE: Be sure to fully insert the tubing in the connector. Push the tubing through the small hole in the connector until you feel resistance. At this point, the tubing is not fully inserted. Then push firmly until the tubing is inserted as far as it will go.

- Step 16 Insert the green tube into the 1/4" opening at the "in" side port of the RO module.

### **RESTART SYSTEM.**

- Step 17 Turn on the incoming cold water. Check the system for leaks and tighten any fittings as necessary. (Check over the next 24 hours to ensure no leaks are present).
- Step 18 Open the tank valve by turning the handle 1/4 turn. Open the RO faucet and leave open until after water begins to trickle out. Then close the RO faucet.
- Step 19 Now you may continue using your RO system for all of your drinking water needs.

**Inspect the reverse osmosis system periodically to ensure the unit is functioning properly.**

## Membrane Maintenance

Membranes have a life expectancy of between 2 and 3 years, depending on the incoming water conditions and the amount of water processed through the RO membrane.

Normally, a membrane would be replaced during a semi-annual or annual filter change. However, if at any time you notice a reduction in water production or an unpleasant taste in the reverse osmosis water, it could be time to replace the membrane.

Depressurize the system by turning off the water supply at the adapta valve and turning valve on tank 1/4 turn.

Step 1 To change the membrane, use a 5/8" wrench to remove the Green tube on the left side of the membrane housing (the end with only one elbow).



Step 2 Remove the cap from the white horizontal membrane housing. Use the hand tool shipped with the unit to loosen. Turn cap counter-clockwise to loosen.



Step 3 Using a pair of pliers, grip and pull firmly on the membrane to remove from the housing and discard in your normal refuse.



Step 4 Unwrap new membrane and lubricate the o-rings with water soluble lubrication before inserting into housing. Insert end with the two black O-rings into the membrane housing.

Step 5 Once membrane has been inserted into the housing, you must take your thumbs and give a firm push to properly seat the membrane. Replace membrane housing cap and tighten. Use the hand tool to tighten, but do not OVERTIGHTEN.

**NOTE:** To be properly seated, the tip of the membrane must be below the housing edge.

Step 6 After replacing membrane housing into clips, attach the green tube to the elbow on cap using a 5/8" wrench.

Step 7 The flow restrictor must be changed each time you change the membrane. Replace the existing flow restrictor with the new one by removing the white compression nuts. Be sure to orientate the flow with the arrow pointing toward the faucet.

Step 8 Follow Start Up instructions to restart your system.

## Maintenance - Check Air Pressure in the Tank

**NOTE: Check air pressure when tank is empty**

Step 1 Using a digital air gauge, check the air pressure in the tank. You should always have between 5-7 psi. If you have more than 7 psi, release air and recheck. If you have less than 5 psi, add air, air can be added with a bicycle pump.

Step 2 Your unit comes with a stand for your storage tank to sit on if you need to turn the unit on its side.

Step 3 This allows for air flow under tank keeping moisture and standing water from rusting on the bottom of your tank which would void your warranty.



Troubleshooting		
PROBLEM	CAUSE	SOLUTIONS
1. Low/Slow Production	Low water pressure	Assure a minimum of 40 psi incoming water pressure. Make sure water supply is turned on and Adapta valve is all the way open
	Crimps in tubing	check tubing and straighten or repair as necessary
	Clogged pre-filters	replace pre-filters
	Fouled membrane	replace membrane and flow restrictor.
2. Milky colored water	Air in System	Air in the system is a normal occurrence with initial start up of the RO system. This milky look will disappear during normal use within 1-2 weeks. If condition reoccurs after filter changes, drain tank 1 to 2 times.
3. Water constantly running/ unit will not shut off	Low water pressure	See #1 above
	Crimp in supply tube	Check tubing and straighten or repair.
	High water pressure	Check incoming water pressure to make sure it does not exceed 80 psi. A pressure relief valve may be necessary.
	High pressure in	Empty storage tank of water. Set tank air pressure to 5 psi. See previous page.
4. Noise from faucet or drain	Air gap faucet	Inherent sound with air-gap faucets
	Location of drain saddle	See diagram for proper location of drain saddle.
	Restriction in drain tube	Clear blockage sometimes caused by debris from garbage disposal or dishwasher.
	High water pressure	Pressure regulator required if pressure exceeds 80 psi
5. Faucet leaks	Crimp in drain line	Check tubing.
	Restriction in drain line	Straighten all drain lines. Clear blockage. Cut off any excess tubing.
	Drain tube clogged	Caused from dishwasher or garbage disposal. Disconnect the 3/8" black line at the drain, clean the 3/8" black line out with a wire, then reconnect. Blowing air through the line will not always remove the clog.
6. Small amount of water in storage tank	System just starting up	Normally it takes 4-6 hours to fill tank. Note: low pressure and/or temperature can drastically reduce production rate.
	Low water pressure	See # 1 above
	Excessive air in tank bladder	Tank pressure is set at the factory and should be 5 psi when empty. Add if below 5 psi and bleed if above 5 psi. Check only when tank is empty. See previous page.
7. Water leaks from the white filter housing	Not properly tightened	Tighten the housing
	Kinked O-ring	Turn off the water supply and release the pressure. Replace the O-ring if necessary. Then lubricate it and make sure the O-ring is seated in the filter housing properly before reinstalling the filter housing.

## Product Guarantee and Warranty

**Multipure 90-Day Guarantee:** Multipure demonstrates its confidence in the performance of its Drinking Water Systems by offering its 90 day money-back guarantee. If you should find the Drinking Water System unsatisfactory, let us know within thirty days of purchase, and we will promptly exchange it or refund your money.

**Multipure Warranty:** Multipure Corporation warrants to the original retail customer its Reverse Osmosis Drinking Water Systems and components to be free of defects in material and workmanship for use under normal care, and will repair or replace any System at no charge (excluding transportation to Multipure headquarters) to the customer during the warranty period. The Housings are warranted for a lifetime (provided that filter has been changed at least once per year). All exterior hoses and attachments to the System are also warranted for defects in material and workmanship for one year.

Multipure Filters and RO membrane are warranted for defects in material and workmanship for use under normal care. The life of the filter cartridges depends upon the amount of impurities in the water to be processed. For optimum performance, it is essential that the filter cartridges and membrane be replaced as specified herein or when they have processed the listed capacity, whichever comes first.

### Limitations and Exclusions

Except as otherwise expressly provided above, Multipure Corporation makes no warranties, express or implied, arising by law or otherwise, including without limitation the implied warranties of merchantability and fitness for a particular purpose, to any person. This limited warranty may not be altered, varied or extended except by a written instrument executed by Multipure Corporation. The remedy of repair or replacement as provided under this limited warranty is exclusive. In no event shall Multipure Corporation be liable for any consequential or incidental damages to any person whether occasioned by negligence of the manufacturer, including without limitation damages of loss of use, cost of substitution, property damage, or other monetary loss.

Warranty is valid only if Drinking Water System is operated within conditions listed herein.

**What this warranty does not cover:** This warranty does not cover defects resulting from improper installation, (contrary to Multipure's written instructions), from abuse, misuse, misapplication, improper maintenance, neglect, alteration accidents, casualties, fire, flood, freezing, environmental factors, water pressure spikes or other such acts of God.

This warranty will be void if defects occur due to failure to observe the following conditions:

1. The Reverse Osmosis System must be hooked up to a potable municipal or well cold water supply.
2. The hardness of the water should not exceed 10 grains per gallon, or 171 mg/L.
3. Maximum incoming iron must be less than 0.2 ppm.
4. The pH of the water must not be lower than 3 or higher than 11.
5. The incoming water pressure must be between 40 and 100 pounds per square inch.
6. Incoming water to the RO cannot exceed 100 degrees F (40 degrees C).
7. Incoming TDS (Total Dissolved Solids) not to exceed 1800 ppm.
8. Do not use with water that is microbiologically unsafe or of unknown quality or without adequate disinfection before or after the system. Systems certified for cyst reduction may be used on disinfected waters that may contain filterable cysts.

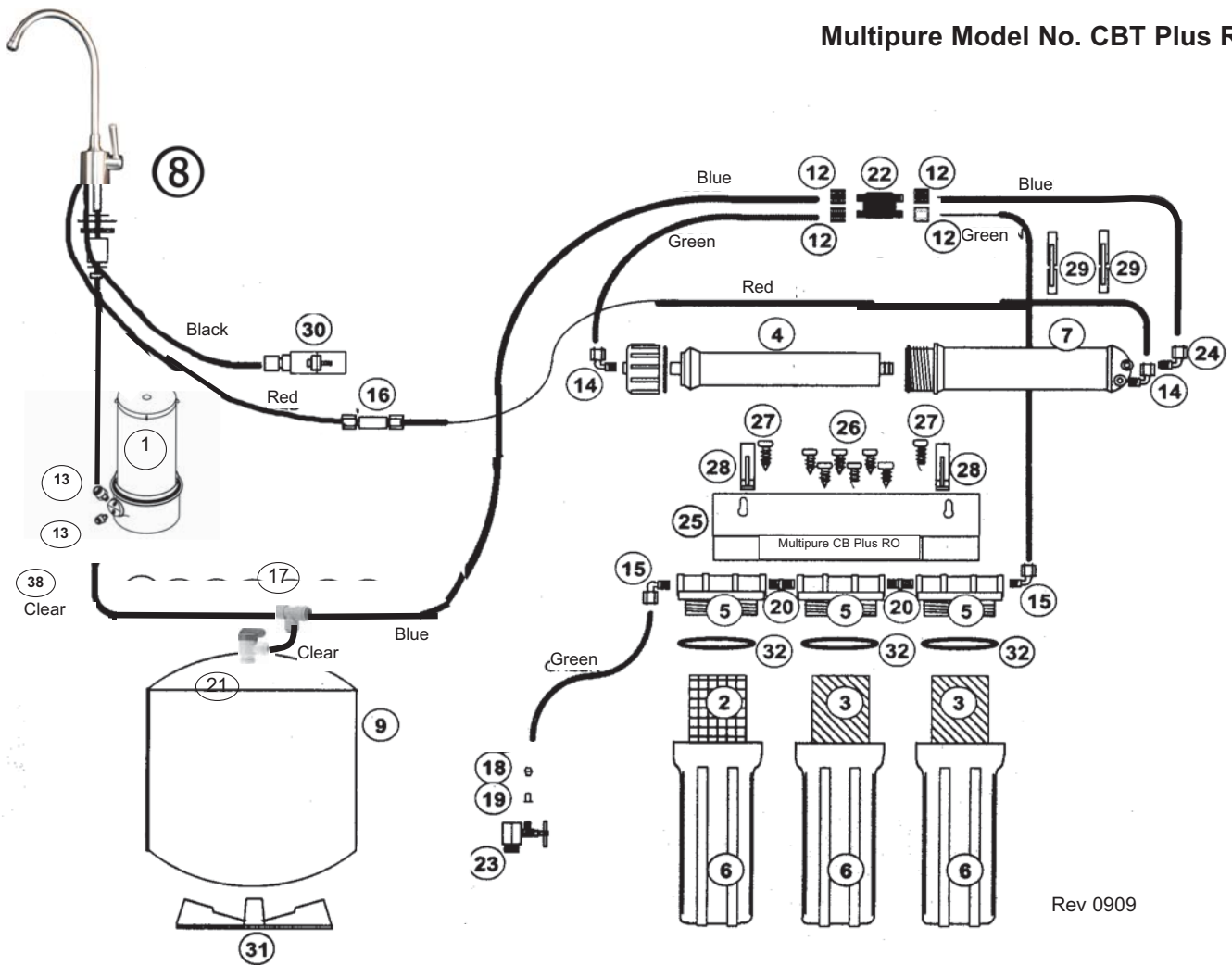

Rev 0909

The reverse osmosis system contains a replaceable treatment component (Item #4), critical for the effective reduction of total dissolved solids. The product water should be tested periodically to verify that the system is performing properly.

Item#	Part #	Description	Item#	Part #	Description
1	CBT-VOC-SI/ CB1100PI	Final Filter Carbon Block Submicron	20	MC171	Hex nipple 1/4" brass
	CBTVOC/CBN	Replacement Cartridge	21	MC1883	Shut off assembly
2	CBC110	Sediment pre-filter	22	MC939B	Valve shut off 1/4"
3	CBC112	Carbon Block 5 micron pre-filter	23	MC930	Adapta/Needle valve, 1/4 x 1/8" - pipe adapter attached
4	CB-ROM	RO Membrane	24	MC935W	Elbow, 1/4 x 1/8" - white
5	MCL10	Housing Lid - 1/4" white	25	MC933	Bracket, (4SV)
6	MCB10	Housing Bottom 10" white	26	MC221	Screw, wood
7	MC950	Membrane Housing vessel - includes o'ring	27	MC941	Bracket screw, 1" - self tapping
8	MC3R03LRC	RO Faucet, tubing attached, white	28	MC940	Membrane clip
9	MC246W	RO tank - 3 gallon - white	29	n/a	omitted intentionally
10	N/A		30	MC942	Drain saddle 3/8"
11	N/A		31	MC946	Tank stand
12	MC932B	Nut, 1/4" black	32	MC943	O'ring for Housing #6
13	MC720	Inlet/Outlet Connector 1/4"	33	n/a	omitted intentionally
14	MC935W	Elbow, 1/4 x 1/8" - white	34	MC239	Green Tubing
15	MC936W	Elbow, 1/4 x 1/4" - white	35	MC236	Black Tubing
16	MC937W	Union, 1/4 x 1/4"	36	MC237	Blue Tubing
17	MC131	tee 1/4 x 1/4 x 1/4	37	MC238	Red Tubing
18	MC142	Delrin sleeve 1/4"	38	MC299	Clear Tubing
19	MC210	Insert, 1/4" brass	39	MC006	Hand tool for RO module and pre- filters (not shown)
			40	D452	Nitrate/Nitrite test strip (not shown)

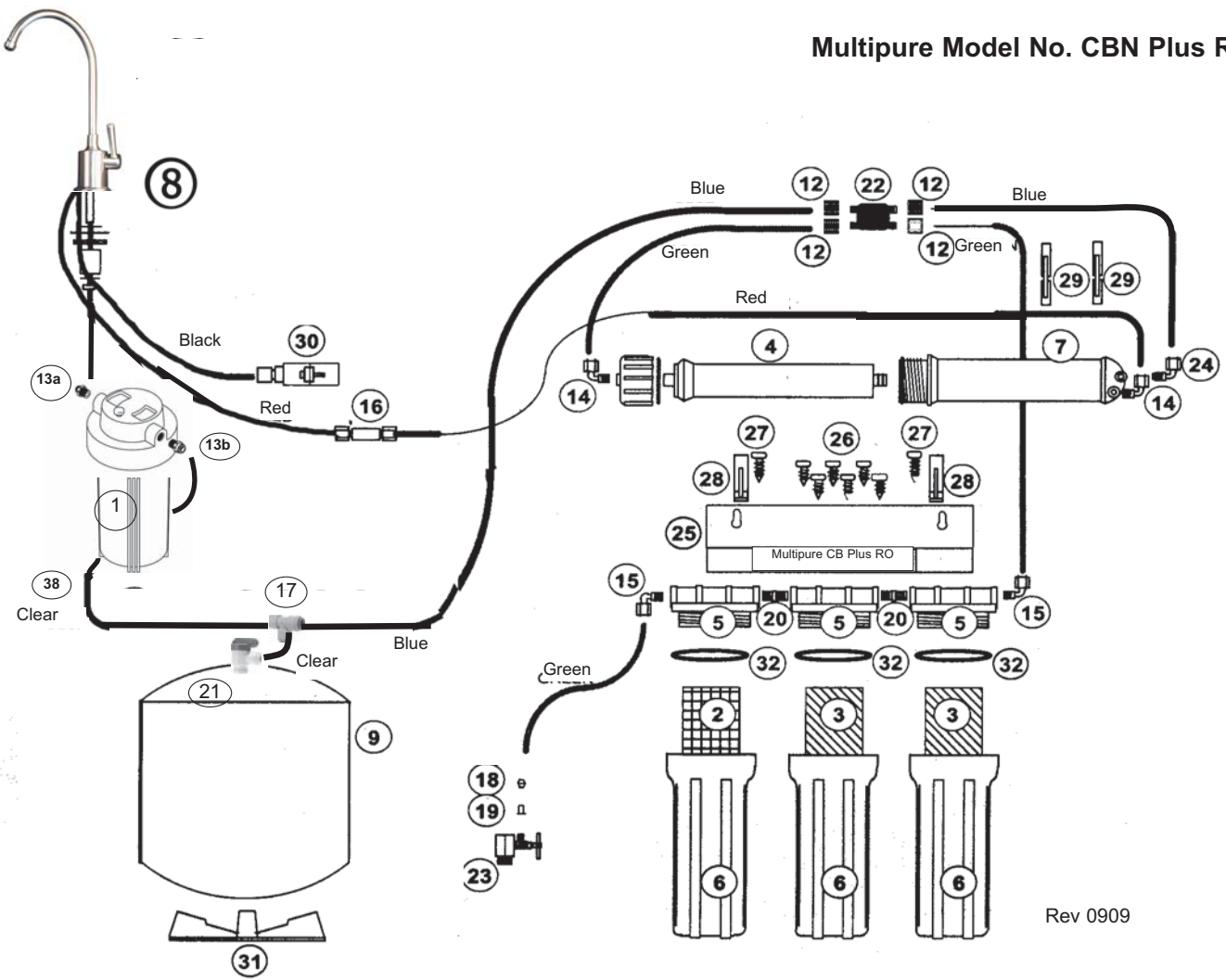

Rev 0909

The reverse osmosis system contains a replaceable treatment component (Item #4), critical for the effective reduction of total dissolved solids. The product water should be tested periodically to verify that the system is performing properly.

Item#	Part #	Description	Item#	Part #	Description
1	CBT-VOC-SI/ CB1100PI	Final Filter Carbon Block Submicron	20	MC171	Hex nipple 1/4" brass
	CBTVOC/CBN	Replacement Cartridge	21	MC1883	Shut off assembly
2	CBC110	Sediment pre-filter	22	MC939B	Valve shut off 1/4"
3	CBC112	Carbon Block 5 micron pre-filter	23	MC930	Adapta/Needle valve, 1/4 x 1/8" - pipe adapter attached
4	CB-ROM	RO Membrane	24	MC935W	Elbow, 1/4 x 1/8" - white
5	MCL10	Housing Lid - 1/4" white	25	MC933	Bracket, (4SV)
6	MCB10	Housing Bottom 10" white	26	MC221	Screw, wood
7	MC950	Membrane Housing vessel - includes o'ring	27	MC941	Bracket screw, 1" - self tapping
8	MC3R03LRC	RO Faucet, tubing attached, white	28	MC940	Membrane clip
9	MC246W	RO tank - 3 gallon - white	29	n/a	omitted intentionally
10	N/A		30	MC942	Drain saddle 3/8"
11	N/A		31	MC946	Tank stand
12	MC932B	Nut, 1/4" black	32	MC943	O'ring for Housing #6
13a	MC744	Outlet Connector 3/8"	33	n/a	omitted intentionally
13b	MC744	Inlet Connector 1/4"	34	MC239	Green Tubing
14	MC935W	Elbow, 1/4 x 1/8" - white	35	MC236	Black Tubing
15	MC936W	Elbow, 1/4 x 1/4" - white	36	MC237	Blue Tubing
16	MC937W	Union, 1/4 x 1/4"	37	MC238	Red Tubing
17	MC131	tee 1/4 x 1/4 x 1/4	38	MC299	Clear Tubing
18	MC142	Delrin sleeve 1/4"	39	MC005	Hand tool for prefilters (not shown)
19	MC210	Insert, 1/4" brass	39	MC006	Hand tool for RO module and pre- filters (not shown)
			40	D452	Nitrate/Nitrite test strip (not shown)

# Performance Data Sheet



Multipure Model No. CB Plus RO Drinking Water Systems have been tested and certified under NSF Standard Nos. 42, 53 and 58 as shown below. The concentration of the indicated substances in water entering the system was reduced to a concentration less than or equal to the permissible limit for water leaving the system, as specified in NSF/ANSI 53, Health Effects.



Substance	Percent Reduction**	Influent challenge concentration (mg/L unless specified)	Maximum permissible product water concentration
<b>ALACHLOR*</b>	>98%	0.05	0.001
<b>ASBESTOS</b>	>99.9%	10 <sup>7</sup> to 10 <sup>8</sup> fibers/L; fibers greater than 10 micrometers in length	99% reduction requirement
<b>ATRAZINE*</b>	>97%	0.1	0.003
<b>BENZENE*</b>	>99%	0.081	0.001
<b>BROMODICHLOROMETHANE (TTHM)*</b>	>99.8%	0.300 +/- 0.30	0.015
<b>BROMOFORM (TTHM)*</b>	>99.8%	0.300 +/- 0.30	0.015
<b>CARBOFURAN (Furadan)*</b>	>99%	0.19	0.001
<b>CARBON TETRACHLORIDE*</b>	98%	0.078	0.0018
<b>CHLORDANE</b>	>99.5%	0.04 +/-10%	0.002
<b>CHLOROBENZENE (Monochlorobenzene)*</b>	>99%	0.077	0.001
<b>CHLOROPICRIN*</b>	99%	0.015	0.0002
<b>CHLOROFORM (TTHM)* (surrogate chemical)</b>	>99.8%	0.300 +/- 0.30	0.015
<b>Cryptosporidium (CYST)</b>	99.95%	minimum 50,000/mL	99.95%
<b>CYST (Giardia; Cryptosporidium; Entamoeba; Toxoplasma)</b>	99.95%	minimum 50,000/mL	99.95%
<b>2, 4-D*</b>	98%	0.110	0.0017
<b>DBCP (see Dibromochloropropane)*</b>	>99%	0.052	0.00002
<b>1,2-DCA (see 1,2-DICHLOROETHANE)*</b>	95%	0.088	0.0048
<b>1,1-DCE (see 1,1-DICHLOROETHYLENE)*</b>	>99%	0.083	0.001
<b>DIBROMOCHLOROMETHANE (TTHM; Chlorodibromomethane)*</b>	>99.8%	0.300 +/- 0.30	0.015
<b>DIBROMOCHLOROPROPANE (DBCP)*</b>	>99%	0.052	0.00002
<b>o-DICHLOROBENZENE (1,2 Dichlorobenzene)*</b>	>99%	0.08	0.001
<b>p-DICHLOROBENZENE (para-Dichlorobenzene)*</b>	>98%	0.04	0.001
<b>1,2-DICHLOROETHANE (1,2-DCA)*</b>	95%	0.088	0.0048
<b>1,1-DICHLOROETHYLENE (1,1-DCE)*</b>	>99%	0.083	0.001
<b>CIS-1,2-DICHLOROETHYLENE*</b>	>99%	0.17	0.0005
<b>TRANS-1,2- DICHLOROETHYLENE*</b>	>99%	0.086	0.001
<b>1,2-DICHLOROPROPANE (Propylene Dichloride)*</b>	>99%	0.08	0.001
<b>CIS-1,3- DICHLOROPROPYLENE*</b>	>99%	0.079	0.001
<b>DINOSEB*</b>	99%	0.17	0.0002
<b>EDB (see ETHYLENE DIBROMIDE)*</b>	>99%	0.044	0.00002
<b>ENDRIN*</b>	99%	0.053	0.00059
<b>Entamoeba (see CYSTS)</b>	99.95%	minimum 50,000/mL	99.95%
<b>ETHYLBENZENE*</b>	>99%	0.088	0.001
<b>ETHYLENE DIBROMIDE (EDB)*</b>	>99%	0.044	0.00002
<b>Furadan (see CARBOFURAN)*</b>	>99%	0.19	0.001
<b>Giardia Lambliia (see CYST)</b>	>99.95%	minimum 50,000/mL	99.95%
<b>HALOACETONITRILES (HAN)*</b>			
<b>BROMOCHLOROACETONITRILE</b>	98%	0.022	0.0005
<b>DIBROMOACETONITRILE</b>	98%	0.024	0.0006
<b>DICHLOROACETONITRILE</b>	98%	0.0096	0.0002
<b>TRICHLOROACETONITRILE</b>	98%	0.015	0.0003
<b>HALOKETONES (HK):*</b>			
<b>1,1-DICHLORO-2-PROPANONE</b>	99%	0.0072	0.0001
<b>1,1,1-TRICHLORO-2-PROPANONE</b>	96%	0.0082	0.0003

\*\* Percent reduction reflects actual performance of Multipure product as specifically tested (at 200% of capacity). Percent reduction shown for VOCs\* reflects the allowable claims for Volatile Organic Chemicals/Compounds as per Tables. Chloroform was used as a surrogate for VOC reduction claims; the Multipure Systems actual reduction rate of Chloroform was >99.8% as tested (at 200% capacity).

Substance	Percent Reduction**	Influent challenge concentration (mg/L unless specified)	Maximum permissible product water concentration
HEPTACHLOR*	>99%	0.25	0.00001
HEPTACHLOR EPOXIDE*	98%	0.0107	0.0002
HEXACHLOROBUTADIENE (Perchlorobutadiene)*	>98%	0.044	0.001
HEXACHLOROCYCLOPENTADIENE*	>99%	0.060	0.000002
LEAD (pH 6.5)	>99.3%	0.15 +/- 10%	0.010
LEAD (pH 8.5)	>99.3%	0.15 +/- 10%	0.010
LINDANE*	>99%	0.055	0.00001
MERCURY (pH 6.5)	>99%	0.006 +/- 10%	0.002
MERCURY (pH 8.5)	>99%	0.006 +/- 10%	0.002
METHOXYCHLOR*	>99%	0.050	0.0001
Methylbenzene (see TOLUENE)*	>99%	0.078	0.001
Monochlorobenzene (see CHLOROBENZENE)*	>99%	0.077	0.001
MTBE (methyl tert-butyl ether)	>96.6%	0.015 +/- 20%	0.005
POLYCHLORINATED BIPHENYLS (PCBs , Aroclor 1260)	>99.9%	0.01 +/- 10%	0.0005
PCE (see TETRACHLOROETHYLENE)*	>99%	0.081	0.001
PENTACHLOROPHENOL *	>99%	0.096	0.001
Perchlorobutadiene (see HEXACHLOROBUTADIENE)*	>98%	0.044	0.001
Propylene Dichloride (see 1,2-DICHLOROPROPANE)*	>99%	0.080	0.001
SIMAZINE*	>97%	0.120	0.004
Silvex (see 2,4,5-TP)*	99%	0.270	0.0016
STYRENE (Vinylbenzene)*	>99%	0.15	0.0005
1,1,1-TCA (see 1,1,1-TRICHLOROETHANE)*	95%	0.084	0.0046
TCE (see TRICHLOROETHYLENE)*	>99%	0.180	0.0010
1,1,2,2- TETRACHLOROETHANE*	>99%	0.081	0.001
TETRACHLOROETHYLENE*	>99%	0.081	0.001
TOLUENE (Methylbenzene)*	>99%	0.078	0.001
TOXAPHENE	>92.9%	0.015 +/- 10%	0.003
Toxoplasma (see CYSTS)	99.95%	minimum 50,000/mL	99.95%
2,4,5-TP (Silvex)*	99%	0.270	0.0016
TRIBROMOACETIC ACID*		0.042	0.001
1,2,4 TRICHLOROBENZENE (Unsymtrichlorobenzene)*	>99%	0.160	0.0005
1,1,1-TRICHLOROETHANE (1,1,1-TCA)*	95%	0.084	0.0046
1,1,2-TRICHLOROETHANE*	>99%	0.150	0.0005
TRICHLOROETHYLENE (TCE)*	>99%	0.180	0.0010
TRIHALOMETHANES (TTHM) (Chloroform; Bromoform; Bromodichloromethane; Dibromochloromethane)	>99.8%	0.300 +/- 0.30	0.015
TURBIDITY	>99%	11 +/- NTU	0.5 NTU
Unsym-Trichlorobenzene (see 1,2,4-TRICHLOROBENZENE)*	>99%	0.160	0.0005
Vinylbenzene (see STYRENE)*	>99%	0.150	0.0005
XYLENES (TOTAL)*	>99%	0.070	0.001

### NSF/ANSI 42 - Aesthetic Effects

The System has been tested according to NSF/ANSI Standard 42 for the reduction of the following substances. The concentration of the indicated substances in water entering the system was reduced to a concentration less than or equal to the permissible limit for water leaving the system.

Substance	Percent Reduction**	Influent challenge concentration	Maximum permissible product water concentration
CHLORAMINE as Aesthetic Effect (As Monochloramine)	>97%	3.0 mg/L +/- 10%	0.5 mg/L
CHLORINE as Aesthetic Effect	99%	2.0 Mg/L +/- 10%	> or = 50%
PARTICULATE, (Nominal Particulate Reduction, Class I, Particles 0.5 TO <1 UM	Class I > 99%	At Least 10,000 particles/mL	> or = 85%

## NSF/ANSI 58 - Reverse Osmosis

The System has been tested according to NSF/ANSI Standard 58 for the reduction of the following substances. The concentration of the indicated substances in water entering the system was reduced to a concentration less than or equal to the permissible limit for water leaving the system, as specified in NSF/ANSI 58.

Substance	Percent Reduction <sup>**</sup>	Influent challenge concentration	Maximum permissible product water concentration
<b>Arsenic V</b> (pentavalent As (V); As(+5); arsenate)	98.4%	0.30 +/- 10%	0.010
<b>Barium</b>	97.9%	10.0 +/- 10%	2.0
<b>Cadmium</b>	98.6%	0.03 +/- 10%	0.005
<b>Chromium, Hexavalent</b>	91.3%	0.3 +/- 10%	0.1
<b>Chromium, Trivalent</b>	94.1%	0.3 +/- 10%	0.1
<b>Copper</b>	99.0%	3.0 +/- 10%	1.3
<b>Cyst</b> (Giardia; Cryptosporidium; Entamoeba; Toxoplasma)	99.99%	50,000 mL	0.9995
<b>Fluoride</b>	93.9%	8.0 +/- 10%	1.5
<b>Lead</b>	98.6%	0.15 +/- 10%	0.010
<b>Nitrate</b>	92.0%	30.0 +/- 10%	10.0
<b>Nitrite</b>	89.0%	3.0 +/- 10%	1.0
<b>Nitrate/Nitrite</b>	91.2%	30.0 +/- 10%	10.0
<b>Perchlorate</b>	96.5%	0.10 +/- 10%	0.006
<b>Radium 226/228</b>	80.0%	25 pCi/L +/- 10%	5 pCi/L
<b>Selenium</b>	92.0%	0.10 +/- 10%	0.05
<b>Total Dissolved Solids (TDS)</b>	96.8%	750 +/- 40 mg/L	187

### NOTES:

1. Multipure Drinking Water Systems have been certified, as indicated, by NSF International for compliance to NSF/ANSI Standard Nos. 42 and 53, and 58.
2. This Multipure Drinking Water System(s) have been certified by the State of California Department of Health Services for the reduction of specific contaminants listed herein.
3. Chloroform was used as a surrogate for claims of reduction of Volatile Organic Chemicals (VOC). Multipure Systems tested at >99.8% actual reduction of Chloroform. Percent reduction shown herein reflects the allowable claims for VOCs as per tables in the Standard.
4. **Do not use with water that is microbiologically unsafe or with water of unknown quality without adequate disinfection before or after the unit. Systems certified for cyst reduction may be used on disinfected waters that may contain filterable cysts.**
5. The System may be used with municipal or well water sources that are treated and tested on a regular basis to ensure bacteriological safe quality of the water.
6. Do not allow water to freeze in the unit. If unit is exposed to freezing temperatures, drain water from unit and remove filters.
7. Do not allow water to sit in unit for extended periods of time (10 or more days) without being used. If unit is to be left unused for more than 10 days, drain all water from the system and remove the filters. Upon your return, reconnect the filters in the housing and continue use. In the event water does sit in the unit for 10 or more days, the system should be flushed by allowing water to flow to waste for about 10 minutes; then continue use as normal.
8. Multipure Drinking Water System Housings are warranted for a lifetime (provided that filter has been changed at least once per year). All exterior hoses and attachments to the System are warranted for defects in material and workmanship for one year. Please see the Owner's Manual for complete product guarantee and warranty information.
9. Please see the Owner's Manual for installation instructions and operating procedures.
10. In compliance with New York law, it is recommended that before purchasing a water treatment system, NY residents have their water supply tested to determine their actual water treatment needs. Please compare the capabilities of the Multipure unit with your actual water treatment needs.
11. Check for compliance with state and local laws and regulations.
12. While testing was performed under standard laboratory conditions, actual performance may vary.
13. The list of substances which the treatment device reduces does not necessarily mean that these substances are present in your tap water.
14. This system is acceptable for treatment of influent concentrations of no more than 27 mg/L nitrate and 3 mg/L nitrite in combination measured as N and is certified for nitrate/nitrite reduction only for water supplies with a pressure of 280 kPa (40 psig) or greater.
15. This system has been tested for the treatment of water containing pentavalent arsenic (also known as As(V), As(+5), or arsenate) at concentrations of 0.30 mg/L or less. This system reduces pentavalent arsenic, but may not remove other forms of arsenic. This system is to be used on water supplies containing a detectable free chlorine residual at the system inlet or on water supplies that have been demonstrated to contain only pentavalent arsenic. Treatment with chloramine (combined chlorine) is not sufficient to ensure complete conversion of trivalent arsenic to pentavalent arsenic. Please see the Arsenic Facts section of the Performance Data Sheet for further information.

## Replacement Filters and Parts

Filter life will vary in proportion to the amount of water used and the level of impurities in the water being processed. Replacement filters, membrane, and parts can be purchased directly from Multipure Corporation. Replacement filter model numbers are shown below. The approximate retail price of replacement filters is also shown below. Prices exclude sales tax and shipping and handling fees (\*prices subject to change without notice).

To dispose of the used filter or membrane, remove it from the housing and place the old filter or membrane in your normal refuse. Carbon filters disposed of in a normal landfill will not release any chemical contamination but will probably continue to adsorb additional contaminants that are disposed of in landfills.

Description	Model No.	Recommended Change Schedule	Approximate Price*
Sediment Pre-Filter (Stage 1)	CBC110	6 months	\$5.00
5 micron Carbon Pre-Filter (Stages 2 & 3)	CBC112	6 months	\$13.00
Sub micron Carbon Post-Filter	CB6	750 gallons (at least once a year)	\$60.00
RO membrane	CB-ROM	2 to 3 years	\$100.00

## MP750 Plus RO Operation and Maintenance Specifications

Depending on water chemistry, water temperature, and water pressure, the CB Plus RO System production and performance will vary. Refer to Owner's Manual for further maintenance requirements and warranty information.

Parameter	Comments
<b>General Use Conditions:</b>	
Maximum Operating Temperature	100°F / 40.5°C
Minimum Operating Temperature	40°F / 0°C
Maximum Working Pressure	100 psi / 7.0 kg/cm <sup>2</sup> The operating pressure in your home should be tested over a 24 hour period to attain the maximum pressure. If it is over 100 psi then a pressure regulator will be required.
Minimum Working Pressure	40 psi / 2.8 kg/cm <sup>2</sup>
pH parameters	3 pH to 11 pH
Iron	0.2 ppm maximum
TDS (total dissolved solids)	< 1800 ppm
Turbidity	< 5 NTU
Hardness	< 10 grains per gallon / 171 mg/L of hardness as CaCO <sub>3</sub> System will operate with hardness over 10 grains, but the membrane life may be shortened.
<b>Specifications:</b>	
Average influent TDS	765 mg/L
Average effluent TDS	23 mg/L
Daily Production Rate (DPR)	17.32 gpd Gallons produced per day
Efficiency Rating	8.91% Efficiency rating means the percentage of the influent water to the system that is available to the user as reverse osmosis treated water under operating conditions that approximate typical daily usage.
Recovery Rating	16.34% Recovery rating means the percentage of the influent water to the membrane portion of the system that is available to the user as reverse osmosis treated water when the system is operated without a storage tank or when the storage tank is bypassed.
Capacity of Tank	1.8 - 2.5 gallons Depending on the incoming water pressure.
Approximate Flow Rate @ 60 psi	0.50 gpm

Note: This Performance Data Sheet addresses the U.S. Environmental Protection Agency (USEPA) Primary and Secondary Drinking Water Regulations in effect at its time of publication, as they related to Multipure's performance in conformance to the industry performance criteria. These regulations are continually being updated at the Federal level. Accordingly, this list of MCLs will be reviewed and amended when appropriate. Please see sales brochure for list of product certifications.

**Facts About Arsenic** (in compliance with NSF Standard 53)

Arsenic (abbreviated As) is a naturally occurring contaminant found in many ground waters. Arsenic in water has no color, taste or odor. It must be measured by a lab test. Public water utilities must have their water tested for arsenic. You can get the results from your water utility. If you have your own well, you can have the water tested. The local health department or the state environmental health agency can provide a list of certified labs. The cost is typically \$15 to \$30. Information about arsenic in water can be found on the Internet at the US Environmental Protection Agency website: [www.epa.gov/safewater/arsenic.html](http://www.epa.gov/safewater/arsenic.html).

There are two forms of arsenic: pentavalent arsenic (also called As(V), As(+5), and arsenate) and trivalent arsenic (also called As(III), As(+3), and arsenite). In well water, arsenic may be pentavalent, trivalent, or a combination of both. Special sampling procedures are needed for a lab to determine what type and how much of each type of arsenic is in the water. Check with the labs in your area to see if they can provide this type of service.

Specially formulated Carbon Block systems are very effective at removing pentavalent arsenic. A free chlorine residual will rapidly convert trivalent arsenic to pentavalent arsenic. Other water treatment chemicals such as ozone and potassium permanganate will also change trivalent arsenic to pentavalent arsenic. A combined chlorine residual (also called chloramine) may not convert all the trivalent arsenic. If you get your water from a public water utility, contact the utility to find out if free chlorine or combined chlorine is used in the water system.

The Multipure CB-As Models are designed to remove only pentavalent arsenic. It will not convert trivalent arsenic to pentavalent arsenic. The system may remove some trivalent arsenic, however, it has not been evaluated for its ability to remove trivalent arsenic. The system was tested in a laboratory to remove pentavalent arsenic. Under lab conditions, as defined in ANSI/NSF Standard 53, the system reduced 0.30 mg/L (ppm) pentavalent arsenic to 0.010 mg/L (ppm) (the USEPA standard for drinking water) or less. The performance of the system may be different at your installation. Have the treated water tested for arsenic to check if the system is working properly.

The Carbon Block filter component of the Multipure CB-As system must be replaced as indicated in the Owner's Manual to ensure the system will continue to remove arsenic and other contaminants. The component identification and locations where you can purchase the component are listed in the installation/operation manual.

**California Department of Health Services  
Certification / Registration**

State of California  
Department of Health Services  
Water Treatment Device  
Certificate Number  
04 - 1629  
Date Issued: September 23, 2004

Trademark/Model Designation	Replacement Element(s)
CBT Plus RO	CBTVOC CBCH10 CBCH12 CB ROM

Manufacturer: Multi Pure Corporation

The water treatment device(s) listed on this certificate have met the testing requirements pursuant to Section 116839 of the Health and Safety Code for the following health related contaminants:

Microbiological Contaminants and Turbidity	Inorganic/Radiological Contaminants
Cysts (protozoa) Turbidity	Arsenic Barium Cadmium Chromium (hexavalent) Chromium (trivalent) Copper Fluoride Lead Mercury Nitrate/Nitrite Radium 226/228 Selenium
Organic Contaminants Chlorane MTBE PCBs Totalpheno VOCs	Sinacetic Styrene 1,1,2,2-Tetrachloroethane Tetrachloroethylene Toluene 2,4,5, TP (Silvex) Trichloroacetic Acid 1,2,4-Trichlorobenzene 1,1,1-Trichloroethane 1,1,2-Trichloroethane Trichloroethylene Trichloroethanes (TCEs) Bromochloromethane Bromoform Chloroform Chlorodibromomethane Xylenes

Rated Service Capacity: 750 gallons      Rated Service Flow: 0.5 gpm

Do not use where water is microbiologically unsafe or with water of unknown quality, except that systems claiming cyst reduction may be used on water containing cysts.

<sup>1</sup> Claims for arsenic reduction shall only be made on water supplies maintaining detectable residual free chlorine at the reverse osmosis (RO) system inlet. Water systems using an in-line chlorinator should provide a minimum of 1 minute chlorine contact time before the RO system.

<sup>2</sup> This system is acceptable for treatment of influent concentrations of no more than 27 mg/L nitrate and 3 mg/L nitrite in combination measured as N and is certified for nitrate/nitrite reduction only for water supplies with a pressure of 280 kPa (40 psig) or greater. A sampling and analysis test kit for nitrate is provided for checking the performance of this system. Frequent analysis is encouraged.

State of California  
Department of Health Services  
Water Treatment Device  
Certificate Number  
04 - 1631  
Date Issued: September 23, 2004

Trademark/Model Designation	Replacement Element(s)
CBN Plus RO	CBN CBCH10 CBCH12 CB ROM

Manufacturer: Multi Pure Corporation

The water treatment device(s) listed on this certificate have met the testing requirements pursuant to Section 116839 of the Health and Safety Code for the following health related contaminants:

Microbiological Contaminants and Turbidity	Inorganic/Radiological Contaminants
Cysts (protozoa) Turbidity	Arsenic Barium Cadmium Chromium (hexavalent) Chromium (trivalent) Copper Fluoride Lead Mercury Nitrate/Nitrite Radium 226/228 Selenium
Organic Contaminants Chlorane MTBE PCBs Totalpheno VOCs	Sinacetic Styrene 1,1,2,2-Tetrachloroethane Tetrachloroethylene Toluene 2,4,5, TP (Silvex) Trichloroacetic Acid 1,2,4-Trichlorobenzene 1,1,1-Trichloroethane 1,1,2-Trichloroethane Trichloroethylene Trichloroethanes (TCEs) Bromochloromethane Bromoform Chloroform Chlorodibromomethane Xylenes

Rated Service Capacity: 750 gallons      Rated Service Flow: 0.5 gpm

Do not use where water is microbiologically unsafe or with water of unknown quality, except that systems claiming cyst reduction may be used on water containing cysts.

<sup>1</sup> Claims for arsenic reduction shall only be made on water supplies maintaining detectable residual free chlorine at the reverse osmosis (RO) system inlet. Water systems using an in-line chlorinator should provide a minimum of 1 minute chlorine contact time before the RO system.

<sup>2</sup> This system is acceptable for treatment of influent concentrations of no more than 27 mg/L nitrate and 3 mg/L nitrite in combination measured as N and is certified for nitrate/nitrite reduction only for water supplies with a pressure of 280 kPa (40 psig) or greater. A sampling and analysis test kit for nitrate is provided for checking the performance of this system. Frequent analysis is encouraged.



**Multipure Corporation**  
7251 Cathedral Rock Drive  
Las Vegas, NV 89128  
866-622-9373  
[info@multipureplus.com](mailto:info@multipureplus.com)  
[www.multipureplus.com](http://www.multipureplus.com)

BR170ROCB/1203

